

////// ZERO-MAX[®]

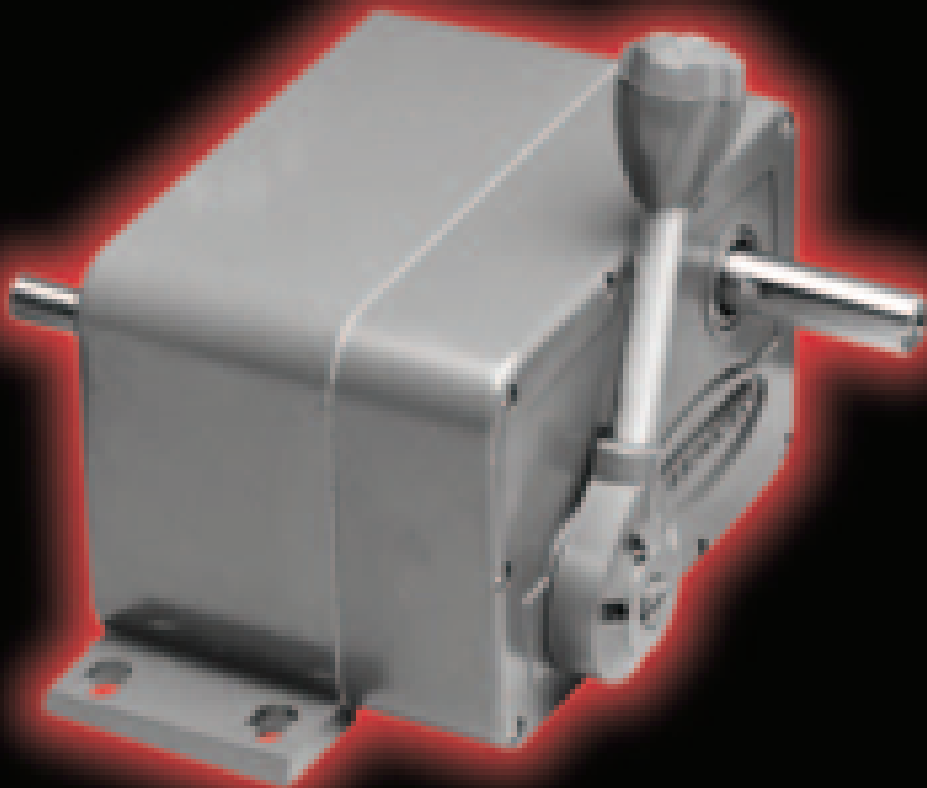

Adjustable Speed Drives

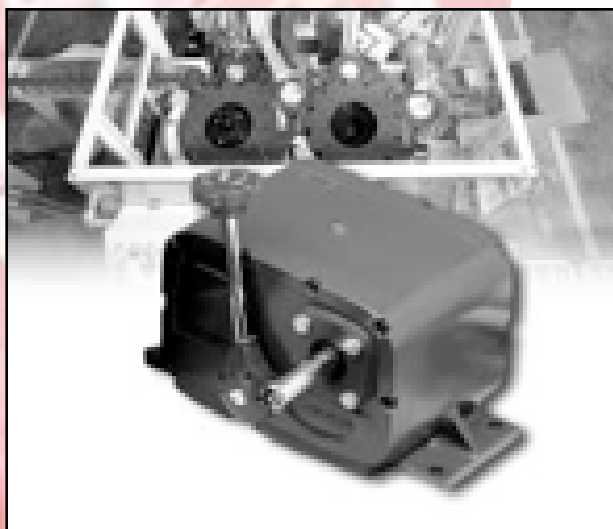

Adjustable Speed Drives

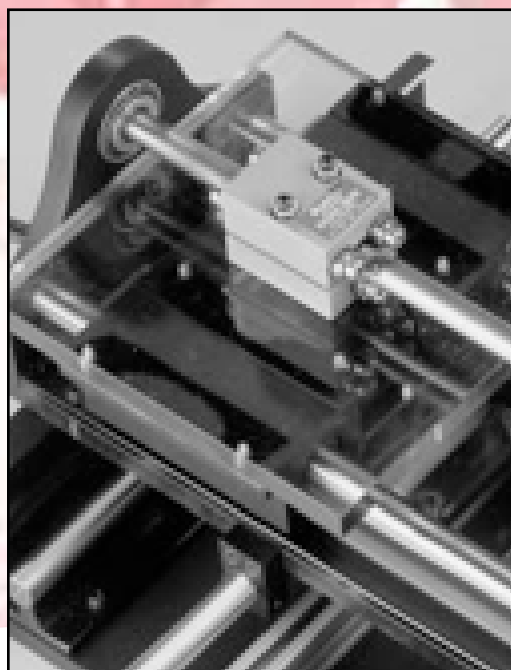

Linear Actuators



Right Angle Gear Drives

For nearly half a century, Zero-Max has supplied industries around the world with millions of adjustable speed drives, right angle gear drives and linear actuators in standard and custom designs. These products are designed to accurately assist in controlling demanding machine processes.

From precise adjustable speed drives used in agricultural equipment and conveyors, to right angle gear drives used in large printing presses, and linear actuators used in special machines to make styrofoam—there are Zero-Max products working dependably every second of every day.

Large and small companies in most manufacturing industries have learned to depend on and trust Zero-Max motion control products.

Adjustable Speed Drives

Zero-Max Drives may be used as a primary or secondary drive. They are available in five sizes providing constant torque of 12 to 200 inch pounds throughout the speed range. Available with optional gearheads, motors and C-flange adapters.

- Introduction Page 6
- How They Work, Features/Benefits 7
- Applications 8
- Matching Components 9
- Controls 10
- Operating Characteristics 11
- How To Select 12
- Torque & Speed Range Chart 13
- Standard/Reverse Drives 14
- Motorized Drives 15
- Drives/Gearheads 16-17



Thousands of Quality Zero-Max Products Are Used Every Second, Every Day, Somewhere In The World

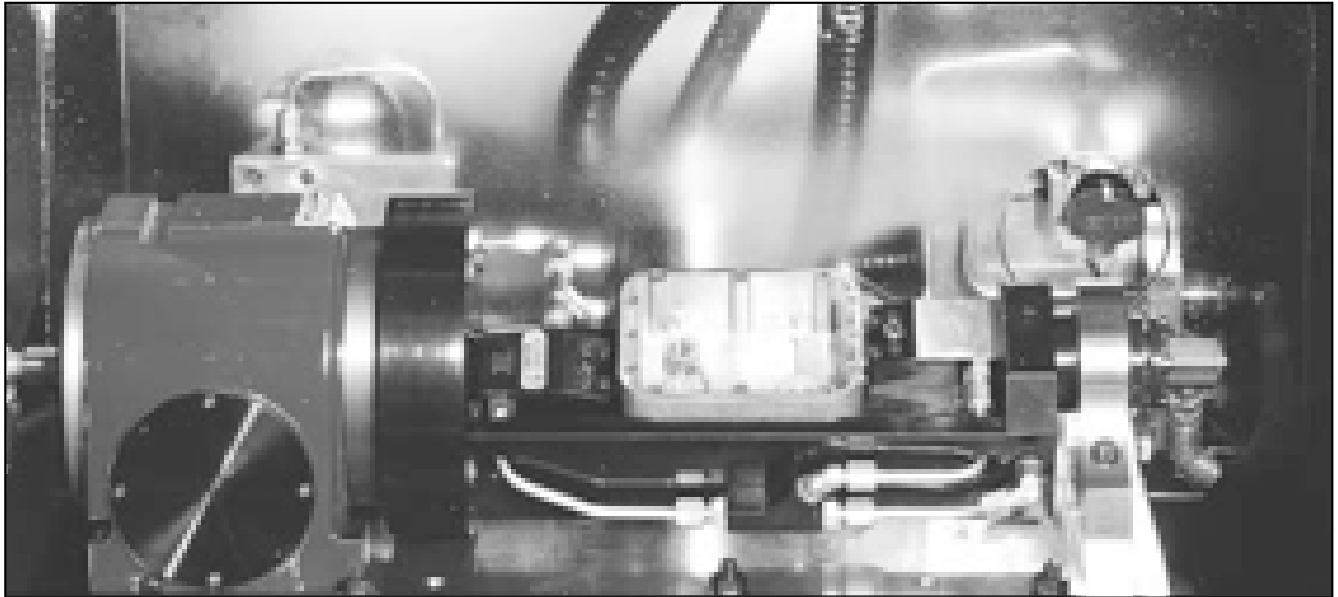

Zero-Max® Adjustable Speed Drives

are manufactured and assembled in our Plymouth, MN. U.S.A. facility. All components are thoroughly inspected prior to assembly. After assembly, each unit is “run-in” for at least four hours to assure consistent quality from unit to unit.

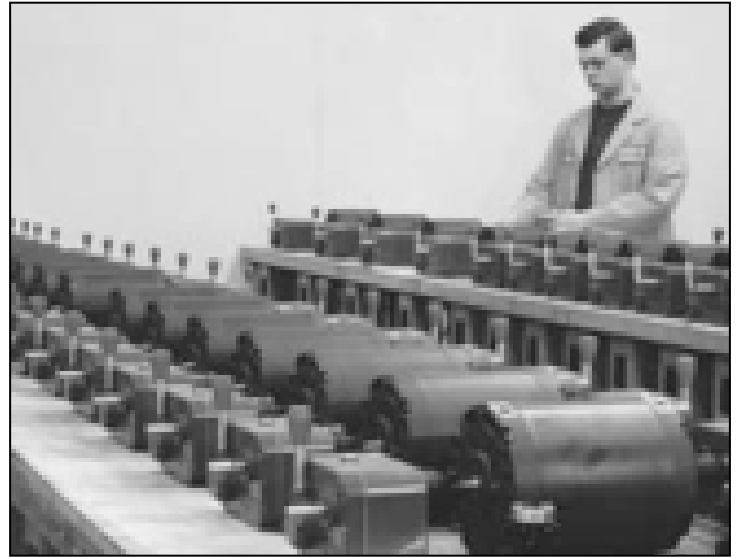

Crown Right Angle Gear Drives

set the standard for 1:1 and 2:1 spiral bevel gear drives. Every component is precision machined, inspected and then carefully assembled. Crown Gear Drives are quiet in operation due to the special care taken in manufacturing and assembly.



Roh'lix® Linear Actuators

are manufactured within tight tolerances to provide accurate linear travel with each shaft revolution. The Roh'lix principle allows the unit to slip when the thrust capacity is exceeded, thereby offering protection to other components in the power train.



Adjustable Speed Drives

Zero-Max is a mechanical adjustable speed drive. Five sizes provide constant torque of 12 to 200 inch pounds throughout the speed range. The speed range is infinitely adjustable from 0 to 1/4 of the input speed under full rated load. This is generally stated as 0-400 RPM under full rated load assuming an input of 1800 RPM.

For lower speed/higher torque applications, some Zero-Max Drives are available with in-line or right angle gearheads. Some Zero-Max Drives may be

purchased with standard electric motors or they may be connected to any rotating power source up to 2000 RPM. Speed adjustments are easily made by moving a lever control through an arc or turning the handwheel of a screw type control. In either case, precise speed control settings are possible.

Over 1 million Zero-Max Drives have been put to work in a wide variety of applications. They are available from distributors in all major markets throughout the world.

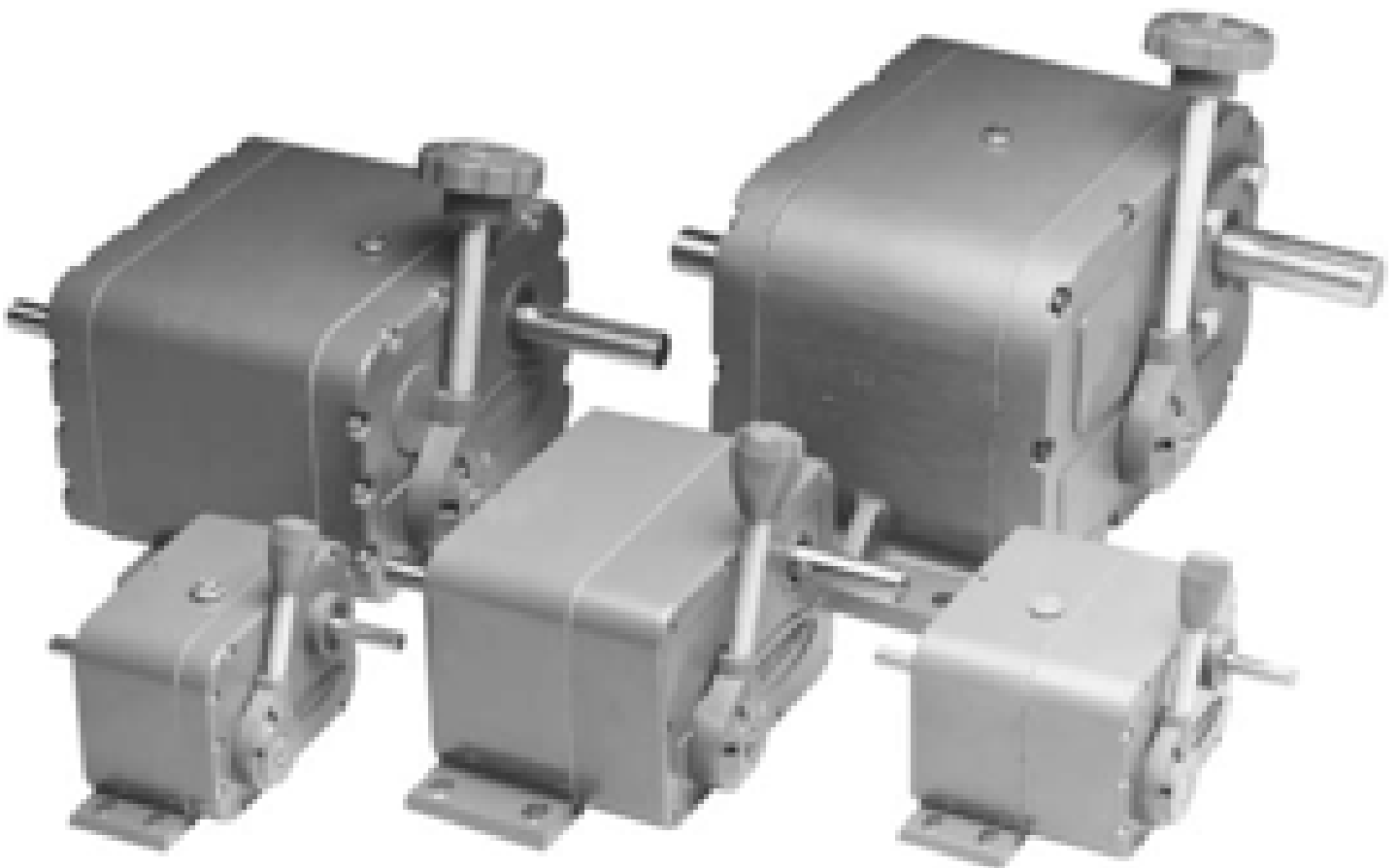

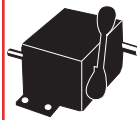

How The Zero-Max[®] Works

Externally, the Zero-Max Drive consists of a rugged, sealed cast case, an input shaft, output shaft and speed control. Speed of the output shaft is regulated precisely and easily through a control lever which includes a convenient locking mechanism or a screw control to hold speed at a desired setting. Models are available with output in clockwise or counter-clockwise rotation to meet individual speed control requirements. Two models are equipped with a reversing lever that permits clockwise, neutral and counter-clockwise operation.

The general principle of operation of Zero-Max Drives gives infinitely adjustable speed by changing the distance that four or more one-way clutches rotate the output shaft successively. The number of strokes per clutch per minute is determined

by the input speed. Since one rotation of the input shaft causes each clutch to move back and forth once, it is readily apparent that the input speed will determine the number of strokes or urgings the clutches give the output shaft per minute. For example, with four clutches working in series and an input of 1800 RPM, the output shaft is urged 7200 times per minute (1800×4) or 120 times per second ($7200 \div 60$). If the input speed is dropped to 900 RPM, the shaft is urged only 3600 times per minute and the maximum output speed will be cut in half.

Looking at Figure 1, the input section, consisting of a shaft (A), eccentrics (B), and connecting rods (C), converts rotary motion into linear motion. At the zero setting, the main links (D) pivot on points (H) and (J) without moving the clutches. At any setting other than zero, the clutches (E) transfer the linear motion back into rotary motion and drive the output shaft (F). A control link (G) swings through arc (K) when the control lever is moved. At any point along arc (K) a different output speed is produced because the direction of throw of the connecting rod is altered from vertical (Figure 1 zero RPM position) toward horizontal (Figure 2 maximum speed position), varying the length of the strokes the main links deliver to the overrunning clutches.

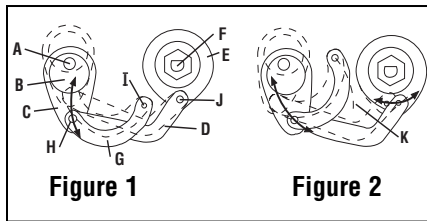

Check These Zero-Max[®] Advantages

Features	Benefits	Features	Benefits
Compact.	Easy to handle/compact.	Leave at one setting.	No daily speed cycling.
Simple to install.	No special wiring/training.	Accurate speed holding.	No "wear-in" period/ constant speed operation.
Simple operation.	Easy to operate with lever or screw control. Repeatable.	Accepts any input.	World's most versatile, economical secondary drive.
Use anywhere on machine.	Accepts input to 2,000 RPM. Ideal secondary controller.	Goes to zero output.	Ideal for use as a clutch.
Constant torque.	Delivers constant torque throughout the speed range.	Simple maintenance.	Factory lubricated.
4:1 speed reduction.	Often usable without additional speed reduction.	Low cost.	Ideal for users and original equipment manufacturers.
Change speed anytime.	Speed set-ups are made quickly and easily.	Proven design.	More than a million sold.
Change speed frequently.	Permits slow or fast, small or large speed changes.	Sealed housing.	Use in most atmospheres/ can be mounted in any position.
Change speed continuously.	Ideal for dancer applications/ constant speed changes.	Shaft/control/motor options.	Versatile.
		Infinitely adjustable.	0-400 RPM speed range with 1800 RPM input.

Adjustable Speed Drive Applications

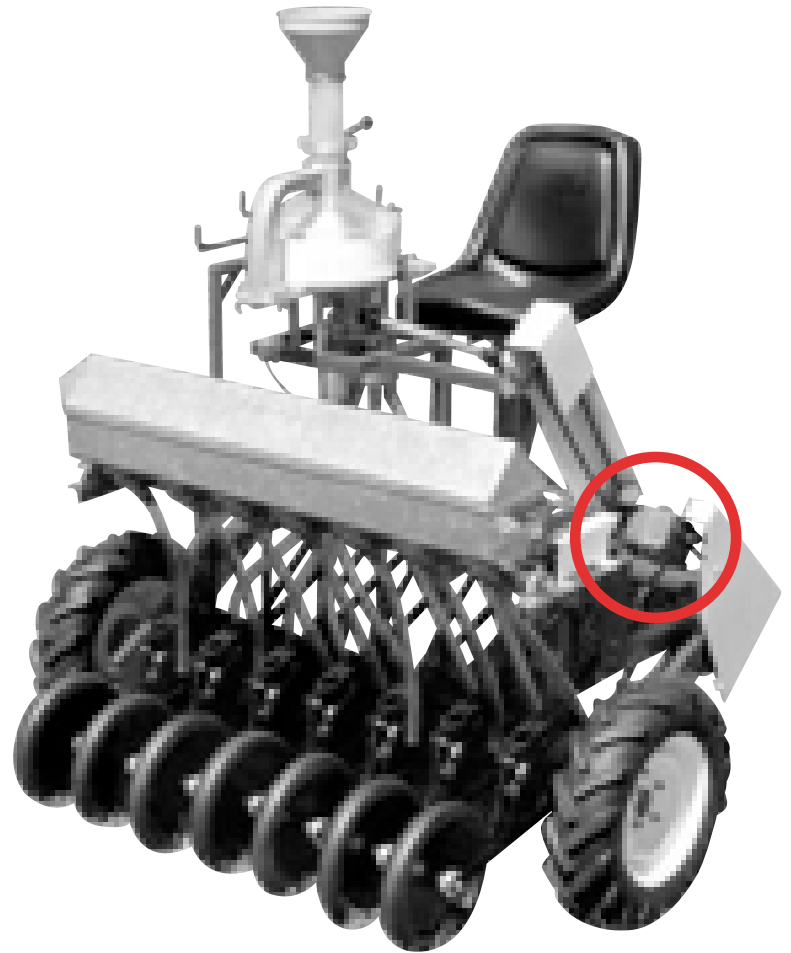
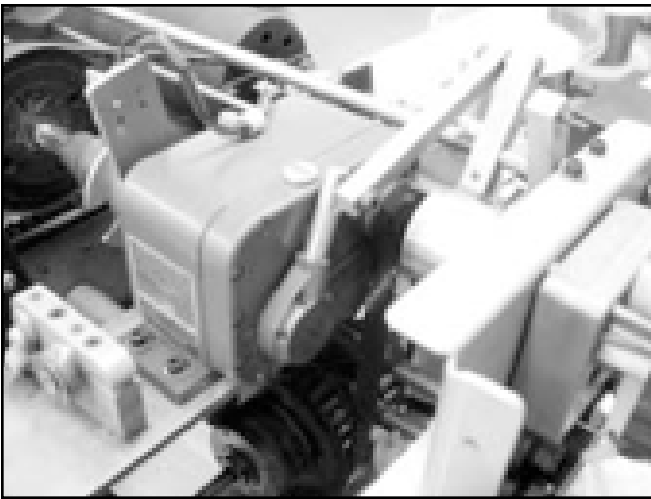
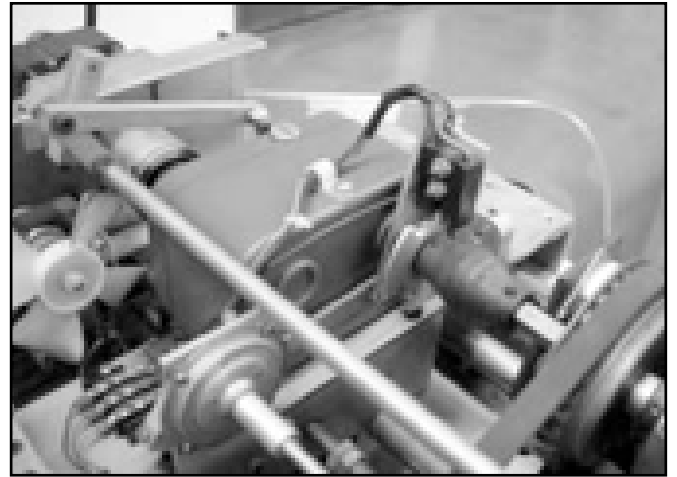

Zero-Max Drives are used on a wide variety of machinery. They may be used as a primary or secondary drive and are available with several control options and shaft arrangements.

Applications include: textile machinery such as looms; food processing machinery such as hamburger presses; agricultural machinery including grain dryers and seeder drives; printing presses utilizing high speed sheeters for stacking finished sheets; metalworking machinery; packaging systems, automated sewing systems, conveying and specialized machines.

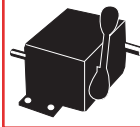

Match Zero-Max[®] Drives To These Components

To achieve the exact performance characteristics you desire, Zero-Max provides the following matching components:

For Model E and JK Drives, a selection of gearheads and motors is available.

For models Y, QX and ZX Drives, C-Flange adapters are available for connecting customer supplied motors to the drive you have selected.

Lever control is standard on all drives. Optional controls include: screw control, extended screw control, extended lever control, extended control shaft, plus flatted and drilled control levers.

Direction of output rotation must be specified and is independent of input direction. Model numbers ending in "1" are CCW output, "2" are CW output and "3" are reversible.

Unidirectional Drives



E Models 1, 2, 41 or 42.
Torque Rating 12 in. lbs.
Speed Range 0-400.
Normal Input 1/4 - 1/3 H.P.



JK Models 1, 2, 41 or 42.
Torque Rating 25 in. lbs.
Speed Range 0-400.
Normal Input 1/4 - 1/3 H.P.



Y Models 1, 2, 41, or 42.
Torque Rating 60 in. lbs.
Speed Range 0-400.
Normal Input 1/2 H.P.



QX Models 1, 2, 41 or 42.
Torque Rating 100 in. lbs.
Speed Range 0-400.
Normal Input 3/4 H.P.



ZX Models 1, 2, 41 or 42.
Torque Rating 200 in. lbs.
Speed Range 0-400.
Normal Input 1-1/2 H.P.

Reversible Drives



E Model 3
Torque Rating 12 in. lbs.
Speed Range 400-0-400.
Normal Input 1/4 - 1/3 H.P.



JK Model 3
Torque Rating 25 in. lbs.
Speed Range 400-0-400.
Normal Input 1/4 - 1/3 H.P.

Gearheads



Right angle/In-Line gearheads available for E and JK Models.

RIGHT ANGLE - 4 Models
W1 4:1 W2 10:1
W3 20:1 W4 40:1

IN LINE - 3 Models
S5 3:1 S6 7.5
S7 20:1

Motors



Many popular voltage, Hz, phase and enclosures are available for use with drive (**E Models 1, 2, 3/ JK Models 1, 2 and 3.**)

C-Face Adapters



MODEL CFY
Includes coupling for 56 frame motor.



MODEL CFQ
Includes coupling for 56 frame motor.



MODEL CFZ
Includes coupling for 56 frame motor.

All C-Face Adapters will accept 56, 143T and 145T frame motors.

Controls For Zero-Max® Drives



Standard Lever



Screw Control

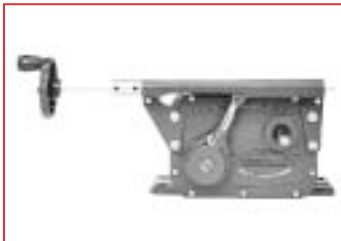

Extended Screw Control



Extended Lever Control



Extended Control Stub



Flatted and Drilled Control Lever

Standard Lever Type Controls

The lever control can be removed from its customary 12 o'clock position and moved to a 6 or 9 o'clock position on E and JK Models and to any position on Y, QX and ZX Models that will not

interfere with the output or input shaft. Flatted and drilled as well as extended levers for easy attachment of any kind of remote control or for use on tension control applications are available.

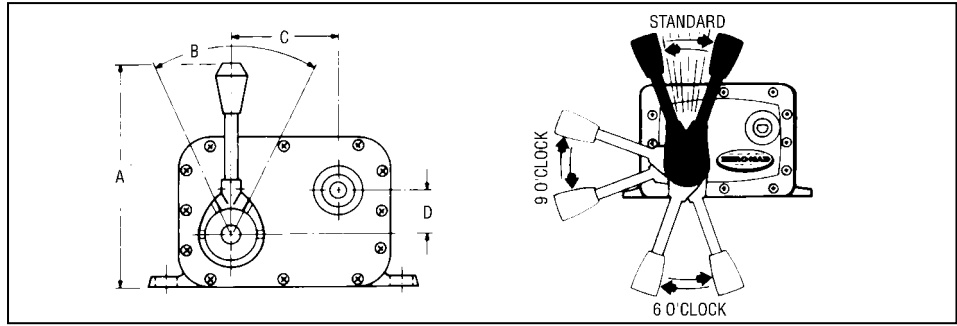

Drive Model	Lever Control Dimensions				Lever Torque	
	A	B	C	D	(Running no load)	(Not running full load)
E	5.25	52°	2.50	1.00	7 in. lbs.	20 in. lbs.
JK	5.25	52°	2.50	1.00	7 in. lbs.	35 in. lbs.
Y	6.75	52°	3.25	1.68	15 in. lbs.	66 in. lbs.
QX	8.25	54°	3.55	1.90	36 in. lbs.	90 in. lbs.
ZX	10.00	63°	3.06	2.40	50 in. lbs.	160 in. lbs.

Control Linearity

Movement of the Zero-Max speed control lever or turn of the screw control screw produces a change in output speed that is non-linear. A typical speed-control curve of a Zero-Max Drive under full rated load is shown to the right.

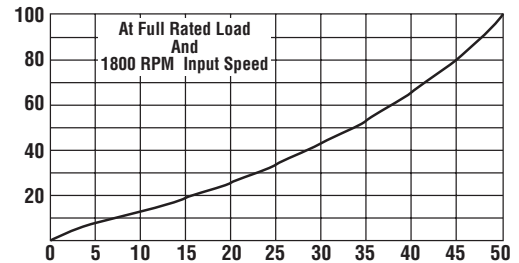

Optional Screw Type Controls

All Zero-Max Drives are available with screw control. Screw controls give very precise control of speed change and many kinds of remote control attachments are easily made. They are positive and easy to calibrate. Kits are available for adding screw control to drives in the field. The hand-wheel can be mounted on either end of the screw.

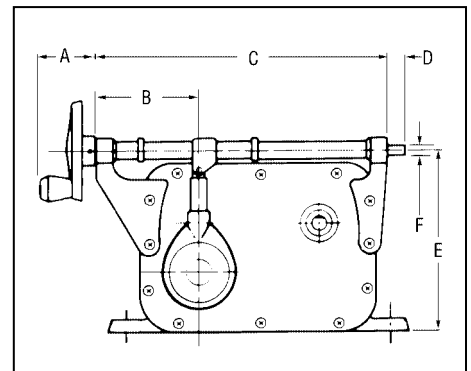

Drive Model	SCREW CONTROL DIMENSIONS						Number of Screw Turns	Screw Torque (inch-Lbs.)
	A	B	C	D	E	F		
E	1.50	2.12	6.06	.37	3.75	.18	38	2 in. lbs.
JK	1.50	2.12	6.06	.37	3.75	.18	38	2 in. lbs.
Y	1.50	2.25	7.42	.44	4.58	.18	50	3 in. lbs.
QX	2.12	2.87	8.81	.37	5.87	.25	68	4 in. lbs.
ZX	2.12	6.12	12.31	.50	7.44	.31	91	4 in. lbs.

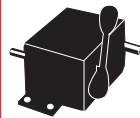

Drive Operating Characteristics...

Input Speed should not exceed 2,000 RPM. There is no minimum, but as input speeds approach zero, slight variations in the angular velocity of the output become noticeable. It is much better to use higher input speeds and take as much reduction as possible from the output shaft to maximize precise speed control.

Direction of the input does not affect direction of output but does affect the speed range and performance of the

Zero-Max Drive. The recommended input rotation direction in relation to output is given below. If output speeds are substantially in excess of rated speeds or if the drive is noisy or vibrating at top speed, the non-preferred direction input is probably being used. Try reversing the motor so the input is in the other direction.

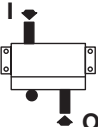
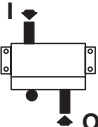
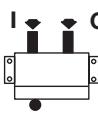
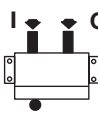
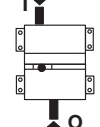
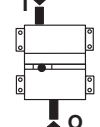
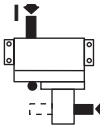
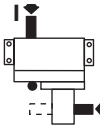
Look In Direction of Arrow To Determine Rotation I- Input O- Output	Standard		Type 41 & 42		Parallel Shaft Gearhead		Right Angle Gearhead	
								
With Output Rotation of	CCW	CW	CCW	CW	CCW	CW	CCW	CW
Recommended Input Rotation is	CW	CCW	CCW	CW	CW	CCW	CW	CCW

Output Speed is infinitely adjustable from 0 to 1/4th of the input speed. Speeds can be maintained or repeated with accuracy of 1% or less of maximum speed in the upper 90% of the range providing output load and input speed are constant.

Zero-Max Drives models vary in their ability to give absolute zero under light loads. All models go to zero output speed under full load.

Output Torque ratings listed for various models are constant throughout the speed range and assume an input speed of 1800 RPM. The drives are designed for continuous duty running at one speed, a variety of speeds or continuously cycled. Additional output torque may be gained by lowering input speed. In general, the torque rating of all models may be increased 25% if the input speed is 900 RPM or lower.

Model	Overhung Load Pounds		Thrust Load Pounds
	Output	Input	
E & JK	20	12	25
Y	} At mid-point of Input and Output Shafts	40	30
QX		50	40
ZX		400	100
S		100	—
W		400	—

Temperature rise of 40° C. above ambient may be expected in the drive assuming input speed of 1800 RPM. This temperature will generate surface heat too hot for continued skin contact. This does not indicate a malfunction nor does it affect the performance of the drive. The drives are built to withstand high operating temperatures but they should never exceed 90° C.

Zero-Max Drives are very **quiet** in operation. Motors and gearheads add to the noise level. For very quiet operating environments, use a resilient mount motor coupled to the drive and provide a resilient mounting surface for all components.

Overload Protection is provided in unidirectional E and JK Models. The breakage protector is not meant to be used as a continuous slip clutch. The torque at which the breakage protector disconnects is substantially higher than the rating of the drive at low speeds. It is, therefore, possible to exceed the rated load of the drive without activating the breakage protector and cause shortened life.

As with all mechanical equipment, care should be taken when starting the Zero-Max under load. Whenever possible, accelerate the load slowly from zero and in the case of reversible drives, bring to zero before reversing the direction of output.

How To Select A Zero-Max® Drive

1. Start By Determining The Torque Required To Start And Run Your Machine. This may be the most important step in selecting the best drive model for your application. All Zero-Max Drives are rated for constant torque and variable horsepower throughout the speed range. Be sure to consider the type of machine and apply the proper service factor.

SERVICE FACTORS		
Type of Load	Type of Duty	
Uniform	8 to 10 hrs./day 1.0	24 hrs./day 1.5
Moderate Shock	1.5	2.0
Heavy Shock	2.0	3.0
Reversing Service Low Inertia High Inertia	2.0 Not Recommended	3.0 Not Recommended

TYPES OF APPLICATIONS	RUNNING TORQUE MULTIPLIER
General machines with ball or roller bearings	1.2–1.3
General machines with sleeve bearings	1.3–1.6
Conveyors and machines with excessive sliding friction	1.6–2.5
Machines that have "high" load spots in their cycle like printing, punch presses and machines with cams /crank-operation.	2.5–6.0

2. Determine Speed Range Required For Your Machine Processes. The Zero-Max Drive speed range of 0-400 RPM is given assuming an input speed of 1800 RPM and full load on the output shaft. The selection of input speed and direction of input have a bearing on final output speed. Lower input speeds reduce the speed range proportionately.

Running the input in the non-preferred direction substantially increases the speed range but may result in shorter life. For best results, run the Zero-Max in the preferred direction and match the speed range to your machine requirement. Take as much reduction as possible, from the output shaft to the load, to provide adequate torque and to maximize accuracy of speed control.

3. Determine Output Shaft Rotation. This is done by looking directly at the end of the output shaft. Model numbers ending in "1" are CCW output, "2" are CW output and "3" are reversible. Use of the Zero-Max in-line and right angle gearheads does not change the direction of rotation of the final output shaft.

4. Select The Proper Method Of Providing Input Speed To The Zero-Max Drive. If the Zero-Max Drive is being used as a secondary drive unit, input is best provided by a timing belt drive. Other methods include chain and sprocket, 'O' ring and step-over gears. Less desirable (because of excessive overhung load applied) are V-belt drives and flat belts.

In any case, care should be taken to mount pulleys, sprockets etc. as close to the Zero-Max Drive case as possible to minimize overhung loads on the shafts. If a Zero-Max motor is to be used, select the standard motor from the chart on page 15.

5. Determine The Type Of Control Best Suited To Your Application. Lever control is supplied as standard with all models of Zero-Max Drives. Other controls are available as discussed on page 10. The lever control is best suited for application requiring rapid and frequent speed changes. The screw type control is best suited for precise settings and speed repeating.

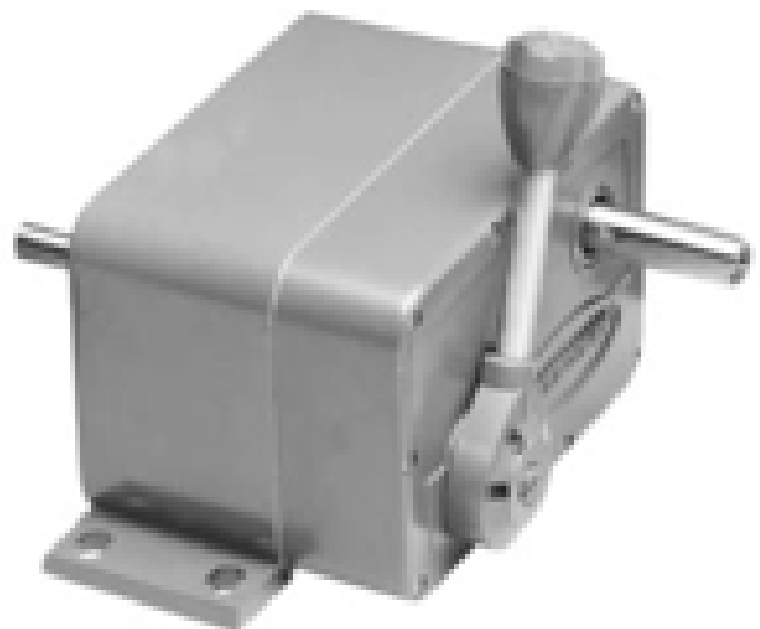

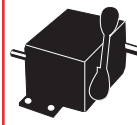

Torque And Speed Range Selection Chart

Standard Zero-Max Drives -- Order By Complete Model Number.

Torque Rating (In. Lbs.)	Speed Range w/ 1800 RPM input	Shaft Arrgemt	Model Number- without Motor Output Shaft Rotation			Net Wt. Lbs.	Shaft Arrgemt	Model Number- with Motor or C-Flange Adapter Output Shaft Rotation			Net Wt. Lbs.
			CCW	CW	Reverse			CCW	CW	Reverse	
12	0-400	1	E1	E2	-	4	5	E1-M3	E2-M3	-	18
	400-0-400	1	-	-	E3	5	5	-	-	E3-M3	19
	0-400	2	E41	E42	-	4	-	-	-	-	-
25	0-400	1	JK1	JK2	-	6	5	JK1-M3	JK2-M3	-	20
	400-0-400	1	-	-	JK3	6	5	-	-	JK3-M3	20
	0-400	2	JK41	JK42	-	6	-	-	-	-	-
30	0-135	3	E1-S5	E2-S5	-	10	6	E1-S5-M3	E2-S5-M3	-	24
	135-0-135	3	-	-	E3-S5	11	6	-	-	E3-S5-M3	25
35	0-100	4	E1-W1	E2-W1	-	9	7	E1-W1-M3	E2-W1-M3	-	23
	100-0-100	4	-	-	E3-W1	10	7	-	-	E3-W1-M3	24
60	0-400	1	Y1	Y2	-	10	8	Y1-CFY	Y2-CFY	-	16
	0-400	2	Y41	Y42	-	10	-	-	-	-	-
70	0-135	3	JK1-S5	JK2-S5	-	12	6	JK1-S5-M3	JK2-S5-M3	-	26
	135-0-135	3	-	-	JK3-S5	12	6	-	-	JK3-S5-M3	26
75	0-100	4	JK1-W1	JK2-W1	-	11	7	JK1-W1-M3	JK2-W1-M3	-	25
	100-0-100	4	-	-	JK3-W1	11	7	-	-	JK3-W1-M3	25
85	0-50	3	E1-S6	E2-S6	-	10	6	E1-S6-M3	E2-S6-M3	-	24
	50-0-50	3	-	-	E3-S6	11	6	-	-	E3-S6-M3	25
90	0-40	4	E1-W2	E2-W2	-	9	7	E1-W2-M3	E2-W2-M3	-	23
	40-0-40	4	-	-	E3-W2	10	7	-	-	E3-W2-M3	24
100	0-400	1	QX1	QX2	-	21	8	QX1-CFQ	QX2-CFQ	-	26
	0-400	2	QX41	QX42	-	21	-	-	-	-	-
135	0-20	3	E1-S7	E2-S7	-	10	6	E1-S7-M3	E2-S7-M3	-	24
	20-0-20	3	-	-	E3-S7	11	6	-	-	E3-S7-M3	25
150	0-50	3	JK1-S6	JK2-S6	-	12	6	JK1-S6-M3	JK2-S6-M3	-	26
	50-0-50	3	-	-	JK3-S6	12	6	-	-	JK3-S6-M3	26
155	0-20	4	E1-W3	E2-W3	-	9	7	E1-W1-M3	E2-W3-M3	-	23
	20-0-20	4	-	-	E3-W3	10	7	-	-	E3-W3-M3	24
160	0-20	3	JK1-S7	JK2-S7	-	12	6	JK1-S7-M3	JK2-S7-M3	-	26
	20-0-20	3	-	-	JK3-S7	12	6	-	-	JK3-S7-M3	26
190	0-40	4	JK1-W2	JK2-W2	-	11	7	JK1-W2-M3	JK2-W2-M3	-	25
	40-0-40	4	-	-	JK3-W2	11	7	-	-	JK3-W2-M3	25
200	0-400	1	ZX1	ZX2	-	32	8	ZX1-CFZ	ZX2-CFZ	-	37
	0-400	2	ZX41	ZX42	-	32	-	-	-	-	-
240	0-10	4	E1-W4	E2-W4	-	9	7	E1-W4-M3	E2-W4-M3	-	23
	10-0-10	4	-	-	E3-W4	10	7	-	-	E3-W4-M3	24
300	0-20	4	JK1-W3	JK2-W3	-	11	7	JK1-W3-M3	JK2-W3-M3	-	25
	20-0-20	4	-	-	JK3-W3	11	7	-	-	JK3-W3-M3	25
300	0-10	4	JK1-W4	JK2-W4	-	11	7	JK1-W4-M3	JK2-W4-M3	-	25
	10-0-10	4	-	-	JK3-W4	11	7	-	-	JK3-W4-M3	25

Standard Shaft Arrangements

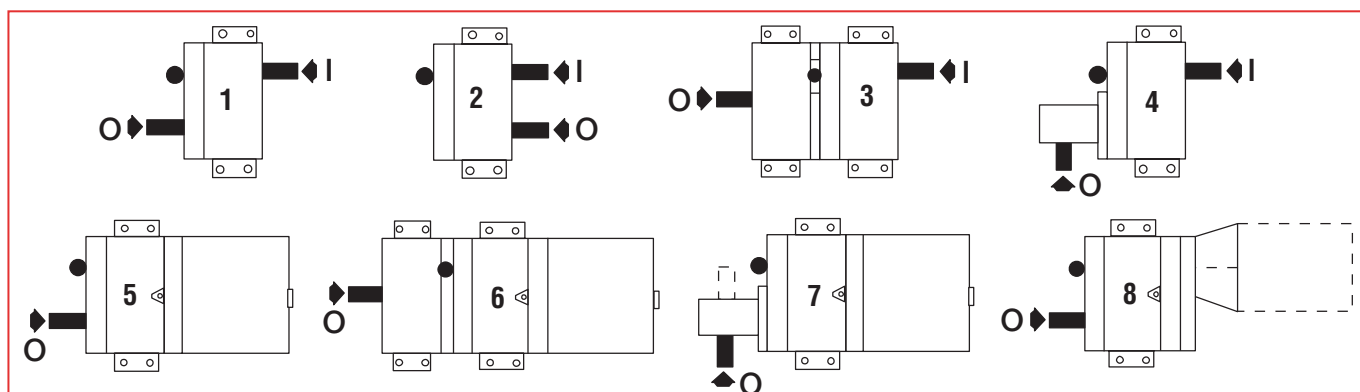

Standard Drives Models E, JK, Y, QX and ZX Dimensions

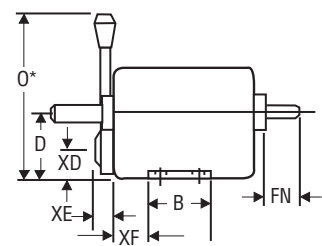
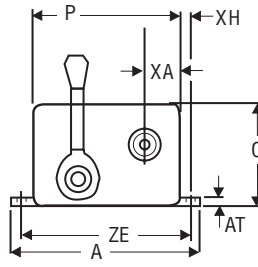
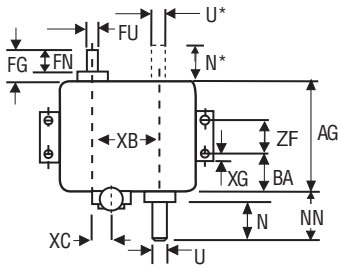

	E1&2	E 41&42	JK1&2	JK 41&42	Y1&2	Y 41&42	QX1&2	QX 41&42	ZX1&2	ZX 41&42
A	6.37	6.37	6.37	6.37	8.50	8.50	10.25	10.25	12.62	12.62
AG	2.84	2.84	3.98	3.98	4.70	4.70	6.81	6.81	6.75	6.75
AT	.31	.31	.31	.31	.31	.31	.37	.37	.50	.50
B	---	2.00	2.00	2.00	2.87	2.87	3.00	3.00	4.75	4.75
BA	1.22	1.22	2.34	2.34	2.28	2.28	2.41	2.41	1.50	1.50
D	2.25	2.25	2.25	2.25	3.00	3.00	3.50	3.50	4.50	4.50
FG	1.12	1.12	1.12	1.12	1.50	1.50	2.00	2.00	2.00	2.00
FN	1.00	1.00	1.00	1.00	1.50	1.50	2.00	2.00	2.00	2.00
FU	.375	.375	.375	.375	.500	.500	.625	.625	.875	.875
H	.28 dia.	.28 dia.	.28 dia.	.28 dia.	.40 dia.	.40 dia.	.41 dia.	.41 dia.	.53 dia.	.53 dia.
N	1.30	---	1.30	---	2.00	---	3.00	---	2.75	---
N*	---	1.00	---	1.00	---	2.00	---	2.87	---	3.31
NN	1.56	---	1.56	---	2.00	---	3.00	---	3.25	---
O	3.50	3.50	3.50	3.50	4.50	4.50	5.50	5.50	7.00	7.00
O*	5.25	5.25	5.25	5.25	6.75	6.75	8.25	8.25	10.00	10.00
P	5.00	5.00	5.00	5.00	6.50	6.50	8.00	8.00	10.00	10.00
U	.375	---	.375	---	.625	---	.750	---	1.00	---
U*	---	.375	---	.375	---	.625	---	.750	---	1.00
XA	1.25	1.25	1.25	1.25	1.53	1.53	2.00	2.00	2.50	2.50
XB	2.50	2.50	2.50	2.50	3.50	3.50	4.00	4.00	5.00	5.00
XC	---	---	---	---	.25	.25	.45	.45	1.94	1.94
XD	1.25	1.25	1.25	1.25	1.31	1.31	1.60	1.60	2.09	2.09
XE	.56	.56	.56	.56	.75	.75	.91	.91	1.00	1.00
XF	.72	.72	1.84	1.84	1.78	1.78	1.89	1.89	1.00	1.00
XG	.50	.50	.50	.50	.50	.50	.50	.50	.50	.50
XH	.25	.25	.25	.25	.50	.50	.62	.62	.62	.62
ZE	5.50	5.50	5.50	5.50	7.50	7.50	9.25	9.25	11.25	11.25
ZF	1.00	1.00	1.00	1.00	1.87	1.87	2.00	2.00	3.75	3.75

Reverse Drives Models E3 and JK3 Dimensions

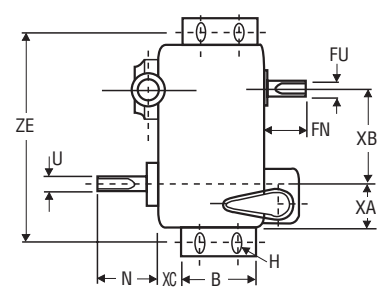
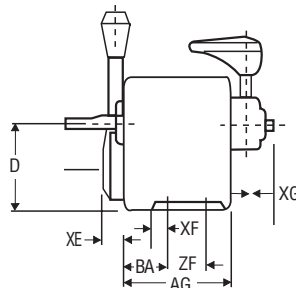
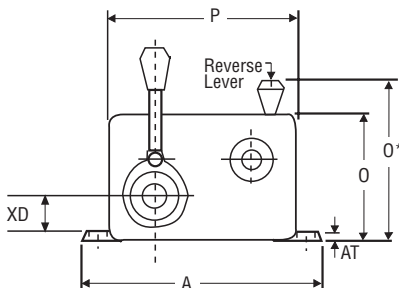

	A	B	D	H Slots	N	O	O*	P	U	AG	AT	BA	FN	FU	XA	XB	XC	XD	XE	XF	XG	ZE	ZF
E3	6.37	2.00	2.25	.28 dia.	1.56	3.50	4.50	5.00	.375	3.23	.31	1.59	1.00	.375	1.25	2.50	1.00	1.25	.56	.50	1.00	5.50	1.00
JK3	6.37	2.00	2.25	.28 dia.	1.68	3.50	4.50	5.00	.375	4.37	.31	2.71	1.00	.375	1.25	2.50	2.12	1.25	.56	.50	1.00	5.50	1.00

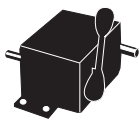

Motorized Drives Models E and JK Dimensions

Z.M. Motor	Used With	ENCL	Horse Power	Voltage	Hz	Phase	C DIMENSION					XG	O'
							w/ E1 & E2	w/ E3	w/ JK1 & JK2	w/ JK3			
M3	E or JK	DP	1/3	115	60	1	12.95	13.35	14.09	14.47	4.37	5.81	
M9		DP	1/3	230	60	1	12.95	13.35	14.09	14.47	4.37	5.81	
M42		DP	1/3	208-230/460	60	3	13.62	14.03	14.75	15.12	4.42	5.81	
M5		TEFC	1/4	115	60	1	14.06	14.38	15.18	15.53	4.37	6.39	
M45		TEFC	1/4	230/460	60	3	14.06	14.38	15.18	15.53	4.37	6.39	

Other motors are available, please contact the factory with your requirements.

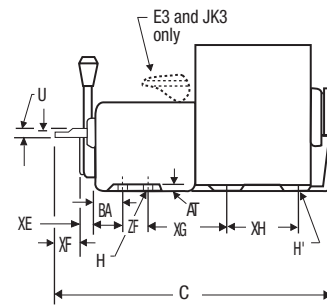
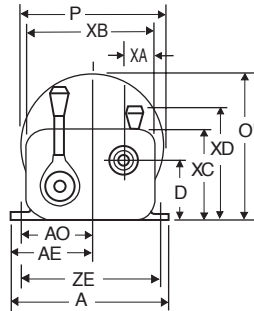

	A	D	H (slots)	H ⁱ (slots)	P	U	AE	AO	AT	BA	XA	XB	XC	XD	XE	XF	XH	ZE	ZF
E1 & E2	6.37	2.25	.28 dia.	.34 dia.	5.62	.375	3.18	2.75	.31	1.22	1.25	5.00	3.50	4.50	.56	1.00	2.75	5.50	1.00
E3	6.37	2.25	.28 dia.	.34 dia.	5.62	.375	3.18	2.75	.31	1.59	1.25	5.00	3.50	4.50	.56	1.00	2.75	5.50	1.00
JK1 & JK2	6.37	2.25	.28 dia.	.34 dia.	5.62	.375	3.18	2.75	.31	2.34	1.25	5.00	3.50	4.50	.56	1.00	2.75	5.50	1.00
JK3	6.37	2.25	.28 dia.	.34 dia.	5.62	.375	3.18	2.75	.31	2.71	1.25	5.00	3.50	4.50	.56	1.00	2.75	5.50	1.00

*Motor slots are centered 4.25 apart.

Drives with C-Flange Adapters Models Y, QX and ZX Dimensions

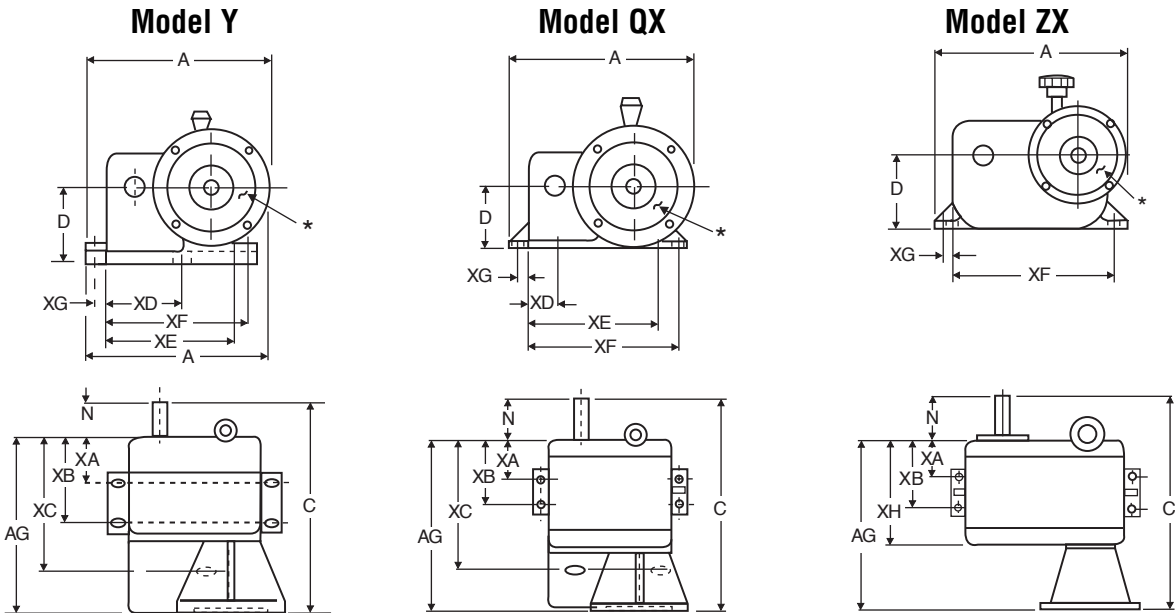

	A	C	D	N	AG	XA	XB	XC	XD	XE	XF	XG
Y	9.31	10.37	3.50	2.00	8.37	2.28	4.15	6.22	3.25	6.50	7.00	.50
QX	10.37	13.97	3.50	3.00	11.10	2.39	4.41	8.37	1.63	7.12	8.63	.63
ZX	12.12	14.12	4.50	3.25	10.88	1.50	5.25	-	-	-	10.62	.62

*Accepts 56, 143T and 145T frame, C-face motor.

Standard Drives with Right Angle and In-Line Gearhead Dimensions

	E1 & E2	E3	JK1 & JK2	JK3	E1 & E2	E3	JK1 & JK2	JK3
	Right Angle Gearheads (W)				With In-Line Gearheads (S)			
A	7.68	7.68	7.68	7.68	-	-	-	-
C'	8.53	8.90	9.65	10.02	8.56	8.93	9.68	10.05
D	3.81	3.81	3.81	3.81	2.25	2.25	2.25	2.25
H	.25 dia.	.25 dia.	.25 dia.	.25 dia.	.28 dia.	.28 dia.	.28 dia.	.28 dia.
H'	.28 dia.	.28 dia.	.28 dia.	.28 dia.	.28 dia.	.28 dia.	.28 dia.	.28 dia.
H"	.34 dia.	.34 dia.	.34 dia.	.34 dia.	.34 dia.	.34 dia.	.34 dia.	.34 dia.
N	2.00	2.00	2.00	2.00	1.50	1.50	1.50	1.50
O	5.84	5.84	5.84	5.84	3.50	3.50	3.50	3.50
P	5.62	5.62	5.62	5.62	5.62	5.62	5.62	5.62
U	.750	.750	.750	.750	.500	.500	.500	.500
AB	3.18	3.18	3.18	3.18	3.18	3.18	3.18	3.18
AG	6.37	6.37	6.37	6.37	6.37	6.37	6.37	6.37
AO	2.75	2.75	2.75	2.75	2.75	2.75	2.75	2.75
AT	.35	.35	.35	.35	.35	.35	.35	.35
AT'	.31	.31	.31	.31	.31	.31	.31	.31
XA	.06	.06	.06	.06	2.50	2.50	2.50	2.50
XB	5.00	5.00	5.00	5.00	5.00	5.00	5.00	5.00
XC	2.38	2.38	2.38	2.38	-	-	-	-
XD	.43	.43	.43	.43	5.25	5.25	5.25	5.25
XE	1.43	1.43	1.43	1.43	1.19	1.19	1.19	1.19
XF	2.87	2.87	2.87	2.87	2.87	2.87	2.87	2.87
XH	2.43	2.84	3.59	3.93	4.44	4.81	5.56	5.93
XI	1.00	1.00	1.00	1.00	1.00	1.00	1.00	1.00
XK	2.75	2.75	2.75	2.75	2.75	2.75	2.75	2.75
XL	2.43	2.43	2.43	2.43	4.34	4.34	4.34	4.34
XN	-	4.50	-	4.50	-	4.50	-	4.50
ZE	5.50	5.50	5.50	5.50	5.50	5.50	5.50	5.50

SHAFT DETAILS		
Model	Output	Input
E & JK	Flat 1/16" deep x 1- 1/8"	Flat 1/16" deep x 3/4"
Y	Keyway 3/16" x 1-5/8"	Flat 1/16" deep x 1"
QX	Keyway 3/16" x 2-1/2"	Keyway 3/16" x 1-1/2"
ZX	Keyway 1/4" x 2-1/8"	Keyway 3/16" x 1-1/4"
S	Flat .072 deep x 1-1/4"	Hollow Shaft
W	Keyway 3/16" x 1-1/4"	Hollow Shaft

*The right to make engineering refinements on all products is reserved. Dimensions and other details subject to change.
When dimensions are critical, detailed drawings should be obtained from the factory.
Dimensions are in inches.*



E and JK Drives with Right Angle Gearheads (W) Dimensions

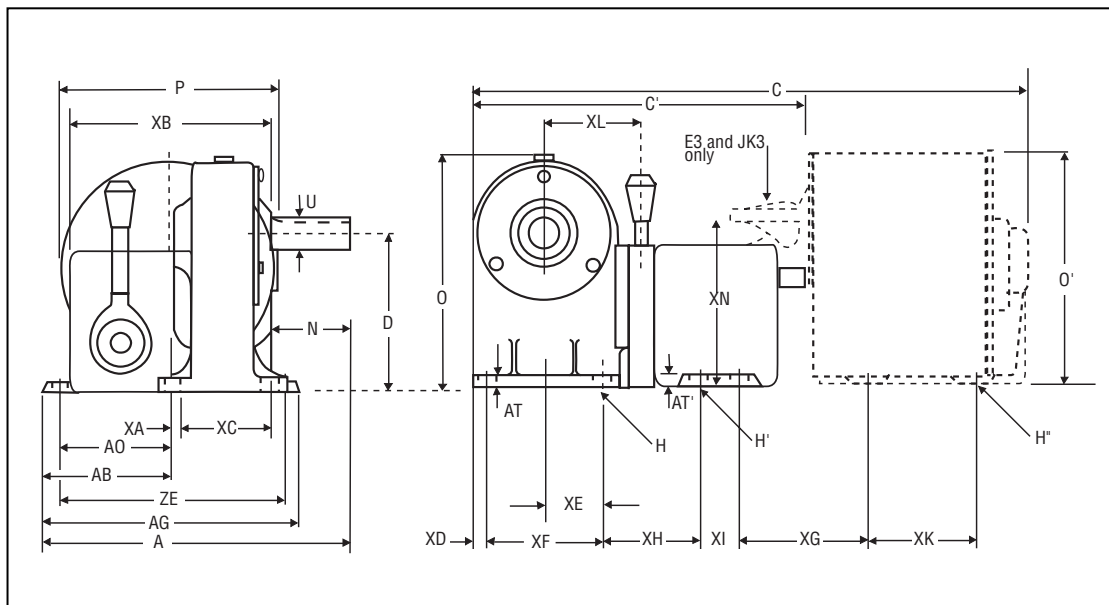

E and JK Drives with In-Line Gearheads (S) Dimensions

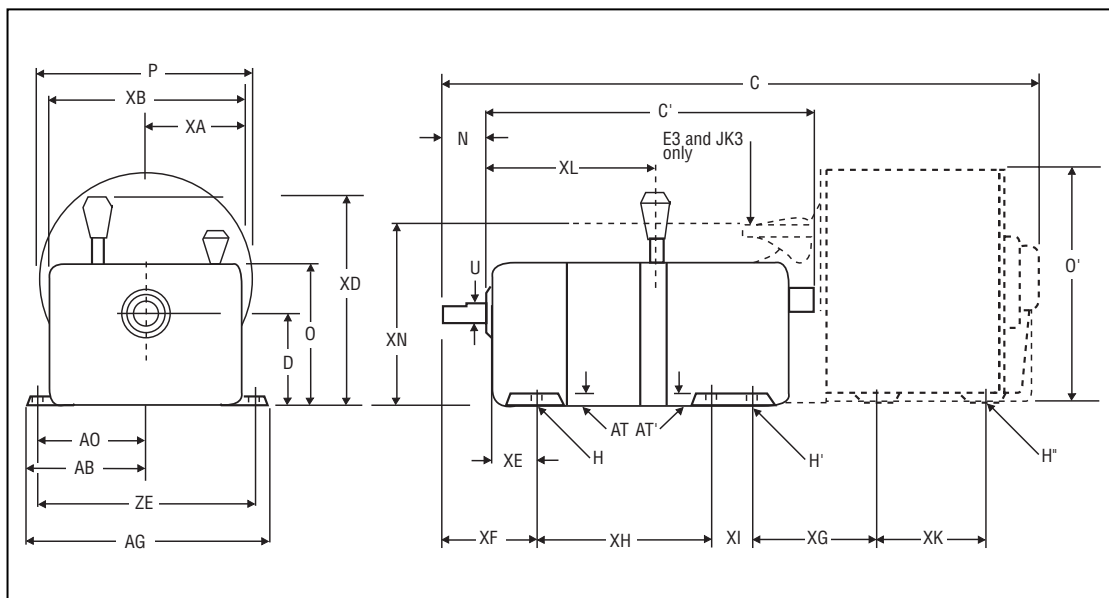

MOTORS*

Motor*	Right Angle Gearheads (W)				In-Line Gearheads (S)				XG	O'
	C				C					
	w/ E1 & E2	w/ E3	w/ JK1 & JK2	w/ JK3	w/ E1 & E2	w/ E3	w/ JK1 & JK2	w/ JK3		
M3 & M9	15.95	16.33	17.06	17.45	17.49	17.87	18.62	19.00	4.37	5.81
M42	16.62	17.00	17.75	18.13	18.18	18.56	19.31	19.68	4.42	5.81
M5	16.75	17.25	18.00	18.38	18.38	19.00	19.62	20.00	4.37	6.39
M45	16.75	17.25	18.00	18.38	18.38	19.00	19.62	20.00	4.37	6.39

*See page 15 for motor data.

Additional Zero-Max® Motion Control Products



CD® Couplings

Composite disc design that outperforms steel discs and elastomeric models. Torsional stiffness. 3° misalignment. Torques to 500,000 in. lbs.



ETP® Bushings

Locks hub to shaft easily without troublesome keys. 26 sizes from 3/4" to 4". Metrics from 8 mm to 100 mm. Stainless steel models.



Torq-Tender®

Accurate overload protection. Dis-engage torques to 3,000 in. lbs. Bores 1/8" to 1-3/4".



Schmidt Couplings

Offset, In-line, Elastomeric and Control-Flex models. Sizes 5 to 500,000 inch lbs. torque.

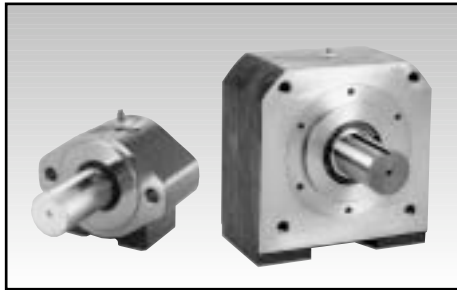

OHLA® - Overhung Load Adapters

Overhung Load Adapters prevent failures. A thru F mounts. Keyed and spline shafts. Speeds to 3600 RPM. Specials.

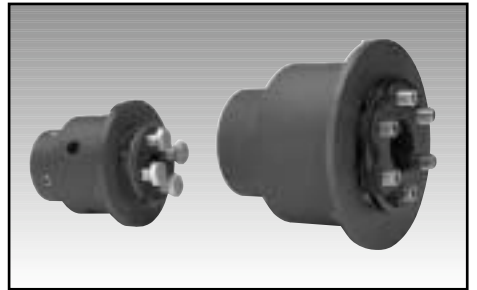

H-TLC Torque Limiters

Corrosion proof design. Adjustable. Bores from .250" to 1.000". Torques from 4 to 500 in. lbs.



Posi-Lok® Shaft Bushings

Inch and Metric sizes to 35 mm. Nickel plating offers corrosion protection.



ServoClass® Double Disc Couplings

Zero backlash, torsionally stiff, high misalignment. Clamp hubs. 8 sizes. Torques to 880 in-lb. Inch and metric bore.



ServoClass® Single Disc Couplings

Zero backlash, smaller package with higher torsional and axial stiffness. Clamp hubs. 8 sizes. Torques to 880 in-lb. Inch and metric bore.

WARRANTY

Zero-Max, Inc. the manufacturer, warrants that for a period of 12 months from date of shipment it will repair, or at its option, replace any new apparatus which proves defective in material or workmanship, or which does not conform to applicable drawings and specifications approved by the manufacturer. All repairs and replacements shall be F.O.B. factory. All claims must be made in writing to the manufacturer.

In no event and under no circumstances shall manufacturer be liable for (a) damages in shipment; (b) failures or damages due to misuse, abuse, improper installation or abnormal conditions of temperature, dirt, water or corrosives; (c) failures due to operation, intentional or otherwise, above rated capacities, and (d) non-authorized expenses for removal, inspection, transportation, repair or rework. Nor shall manufacturer ever be liable for consequential and incidental damages, or in any amount greater than the purchase price of the apparatus.

Zero Max, Inc. reserves the right to discontinue models or to change specifications at any time without notice. No discontinuance or change shall create any liability on the part of Zero-Max, Inc. in respect to its products in the hands of customers or products on order not incorporating such changes even though delivered after any such change.

This warranty is in LIEU OF ALL OTHER WARRANTIES, EXPRESS OR IMPLIED, INCLUDING (BUT NOT LIMITED TO) ANY IMPLIED WARRANTIES OF MERCHANTABILITY OR FITNESS FOR A PARTICULAR PURPOSE. THE TERMS OF THIS WARRANTY CONSTITUTE ALL BUYER'S OR USER'S SOLE AND EXCLUSIVE REMEDY, AND ARE IN LIEU OF ANY RIGHT TO RECOVER FOR NEGLIGENCE, BREACH OF WARRANTY, STRICT TORT LIABILITY OR UPON ANY OTHER THEORY. Any legal proceedings arising out of the sale or use of this apparatus must be commenced within 18 months of the date of purchase.

CAUTION: Rotating equipment must be guarded. Also refer to OSHA specifications and recommendations.

Zero-Max®, CD®, ETP®, ServoClass®, Torq-Tender®, Control-Flex®, Posi-Lok® and Roh'Lix® are registered trademarks of Zero-Max, Inc. OHLA™ is a trademark of Zero-Max, Inc.

© Zero-Max 2003 Printed in U.S.A.

////// ZERO-MAX

13200 Sixth Avenue North, Plymouth, Minnesota 55441-5509
800-533-1731 • (763) 546-4300 • Fax (763) 546-8260 • www.zero-max.com