

The PEER R series, starting with the 1/4 inch bore, is available up to 1 1/2 inches. The Conrad construction of the R series enables these bearings to take a thrust load as well as a radial load. The well designed ball compliment and selection of retainers permit use of this series in high speed motor applications. This series is produced open, shielded or sealed. Shield and sealed bearings are made slightly wider as shown in the dimension table. Stainless steel 440C material is available upon request. Radial clearance is selected in accordance with applications ranging from C2 -C0-C3-C4 fits.

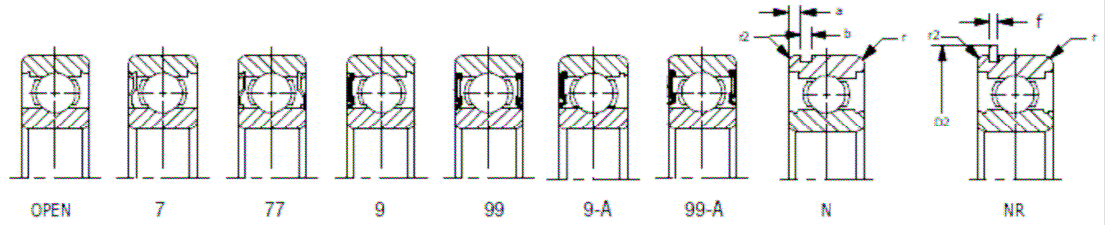
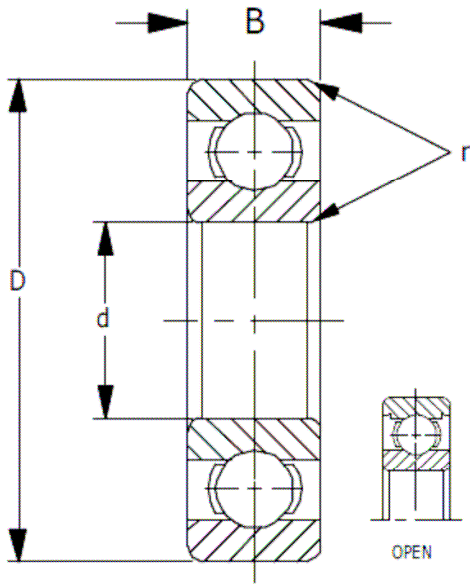

Part Number	Bore d	Tolerance +.0000 to minus	OD D	Tolerance +.0000 to minus	Width - B		+ fillet radius r	Basic Load Ratings lbf N		Weight lb Kg	Limiting speed (rpm)		
					Open inch	Sealed/ Shielded inch		Tolerance +.0000 to minus	Dynamic Cr		Static Cor	oil	grease
R8	1/2 .5000	.0003	1 1/8 1.1250	.00035	.2500	.3125	.0050	.006 .16	1150 5,116	540 2,402	0.039 0.018	30,000	26,000