

EPT E CATALOG - PART DETAIL

Browning AK20X5/8

Finished Bore Sheave, 5/8" Bore, Uses 3L, A Belt, 1 Groove

Product Type:	Finished Bore Sheave
Type of Belt:	3L, A
Number of Grooves:	1
Warning:	Do not use these "AK" sheaves with bores 1" and under with gripnotch belt ratings.
Material:	Cast Iron
Typical Applications:	
Feature 1:	Largest Selection of finished bore sheaves of any other manufacturer - Browning offers finished bore sheaves in both A & B Combination (A/B) configuration. 1, 2 & 3 Grooves are available to meet any fractional horsepower requirement.



Images may not be an exact representation of the product

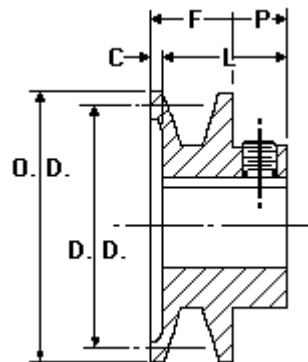

Part No	Description	Bore	D.D. (A)	PD (A)	D.D. (3L)	C
1025840	AK20X5/8	5/8	1.80	2.0	1.46	5/32
F	P	L	O.D.			
21/32	7/16	15/16	2.00			